

# QPA3240

GaAs/GaN Power Doubler Hybrid  
45MHz to 1218MHz

The QPA3240 is a Hybrid Power Doubler amplifier module. The part employs GaAs pHEMT die and GaN HEMT die, has extremely high output capability, and is operated from 45MHz to 1218MHz. It provides excellent linearity and superior return loss performance with low noise and optimal reliability. DC current of the device can be externally adjusted for optimum distortion performance versus power consumption over a wide range of output level.



Package: SOT-115J

## Features

- Excellent Linearity
- Superior Return Loss Performance
- Optimal Reliability
- Low Noise
- Unconditionally Stable Under All Terminations
- 24.5dB Min. Gain at 1218MHz
- 480mA Max.
- Extra Pin For Current Adjustment

## Applications

- 45MHz to 1218MHz CATV Amplifier Systems
- DOCSIS 3.1 Compliant

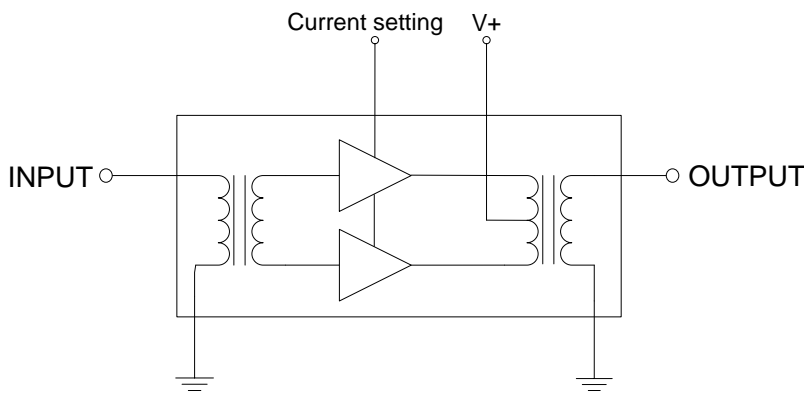

Functional Block Diagram

## Ordering Information

QPA3240                      Box with 50 pieces

# QPA3240

## Absolute Maximum Ratings

Parameter	Rating	Unit
RF Input Voltage (single tone)	75	dBmV
DC Supply Over-Voltage (5 minutes)	30	V
Storage Temperature	-40 to +100	°C
Operating Mounting Base Temperature	-30 to +100	°C



**Caution!** ESD sensitive device.



RFMD Green: RoHS status based on EU Directive 2011/65/EU (at time of this document revision), halogen free per EN 14582 : 2007, < 1000ppm each of antimony trioxide in polymeric materials and red phosphorus as a flame retardant, and <2% antimony in solder.

Exceeding any one or a combination of the Absolute Maximum Rating conditions may cause permanent damage to the device. Extended application of Absolute Maximum Rating conditions to the device may reduce device reliability. Specified typical performance or functional operation of the device under Absolute Maximum Rating conditions is not implied.

## Electrical Specifications

Parameter	Specification			Unit	Condition
	Min	Typ	Max		
General Performance. Test conditions unless otherwise noted: $V_+ = 24V$ ; $T_{MB} = 30^\circ C$ ; $Z_S = Z_L = 75\Omega$ , IDC set >370mA					
Operating Frequency Range	45		1218	MHz	
Power Gain	23.3	23.8	24.3	dB	$f = 45MHz$
	24.5	24.8	26.0	dB	$f = 1218MHz$
Slope[1]	0.5	1.0	2.0	dB	$f = 45MHz$ to 1218MHz
Flatness of Frequency Response			0.8	dB	$f = 45MHz$ to 1218MHz
Input Return Loss	20			dB	$f = 45MHz$ to 320MHz
	19			dB	$f = 320MHz$ to 640MHz
	18			dB	$f = 640MHz$ to 870MHz
	18			dB	$f = 870MHz$ to 1000MHz
	17			dB	$f = 1000MHz$ to 1218MHz
Output Return Loss	20			dB	$f = 45MHz$ to 320MHz
	19			dB	$f = 320MHz$ to 640MHz
	18			dB	$f = 640MHz$ to 870MHz
	18			dB	$f = 870MHz$ to 1000MHz
	17			dB	$f = 1000MHz$ to 1218MHz
Noise Figure		3.0	4.0	dB	$f = 50MHz$ to 1218MHz
Total Current Consumption (DC)		470.0	480.0	mA	

# QPA3240



RFMD + TriQuint = Qorvo

Parameter	Specification			Unit	Condition
	Min	Typ	Max		
Distortion Data 40MHz to 550MHz. Test conditions: V+ = 24V; TMB = 30°C; ZS = ZL = 75Ω, IDC=IDC typical					
CTB		-73	-68	dBc	VO = 62 dBmV at 1000MHz, 18dB extrapolated tilt, 79 analog channels plus 75 digital channels (-6dB offset)[2][5]
XMOD		-68	-63	dBc	
CSO		-76	-70	dBc	
CIN	55	57		dB	
Distortion Data 40MHz to 550MHz. Test conditions: V+ = 24V; TMB = 30°C; ZS = ZL = 75Ω, IDC=IDC typical					
CTB		-80		dBc	VO = 62 dBmV at 1218MHz, 22dB extrapolated tilt, 79 analog channels plus 111 digital channels (-6dB offset)[3][5]
XMOD		-77		dBc	
CSO		-80		dBc	
CIN		58		dB	
Distortion Data 40MHz to 550MHz. Test conditions: V+ = 24V; TMB = 30°C; ZS = ZL = 75Ω, IDC=400mA					
CTB		-72		dBc	VO = 62 dBmV at 1218MHz, 22dB extrapolated tilt, 79 analog channels plus 111 digital channels (-6dB offset)[3][6]
XMOD		-67		dBc	
CSO		-70		dBc	
CIN		50		dB	

- The slope is defined as the difference between the gain at the start frequency and the gain at the stop frequency.
- 79 analog channels, NTSC frequency raster: 55.25MHz to 547.25MHz, +44dBmV to +53.4dBmV tilted output level, plus 75 digital channels, -6dB offset relative to the equivalent analog carrier.
- 79 analog channels, NTSC frequency raster: 55.25MHz to 547.25MHz, +40dBmV to +49.4dBmV tilted output level, plus 111 digital channels, -6dB offset relative to the equivalent analog carrier.
- Composite Triple Beat (CTB) - The CTB parameter is defined by the NCTA. Composite Second Order (CSO) - The CSO parameter (both sum and difference products) is defined by the NCTA. Cross Modulation (XMOD) - Cross modulation (XMOD) is measured at baseband (selective voltmeter method), referenced to 100% modulation of the carrier being tested. Carrier to Intermodulation Noise (CIN) - The CIN parameter is defined by ANSI/SCTE 17 (Test Procedure for carrier to noise).
- Test condition: Pin 4 not connected
- Test condition: Pin 4 connected to GND via 3.9k resistor

# QPA3240

## Current Adjustment Using Hybrid Pin 4

The QPA3240 can be operated over a wide range of current to provide maximum required performance with minimum current consumption. A single external resistor connected between pin 4 and GND allows variation of current between 470mA and 150mA (typ.). Within the recommended range of current between 470mA and 370mA gain (S21) change is less than 0.2dB and noise figure change is less than 0.1dB. If pin 4 is not connected the devices operates at maximum current, see table below.

Examples of connecting pin 4:

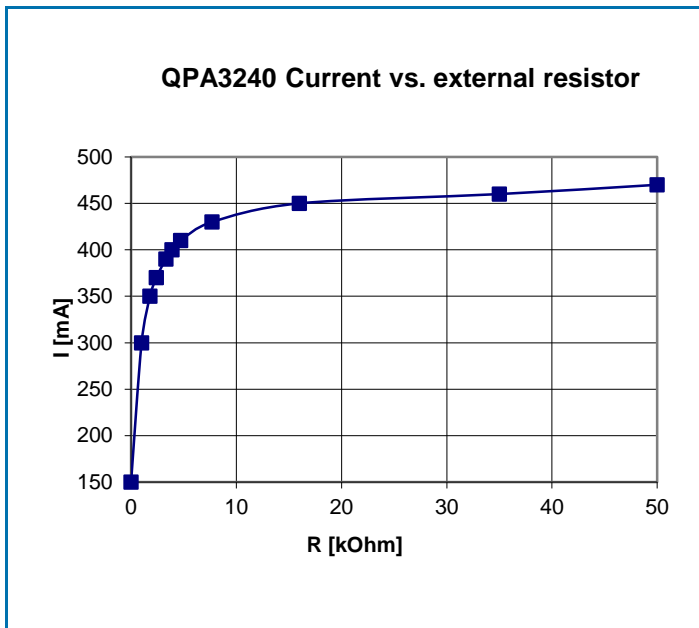
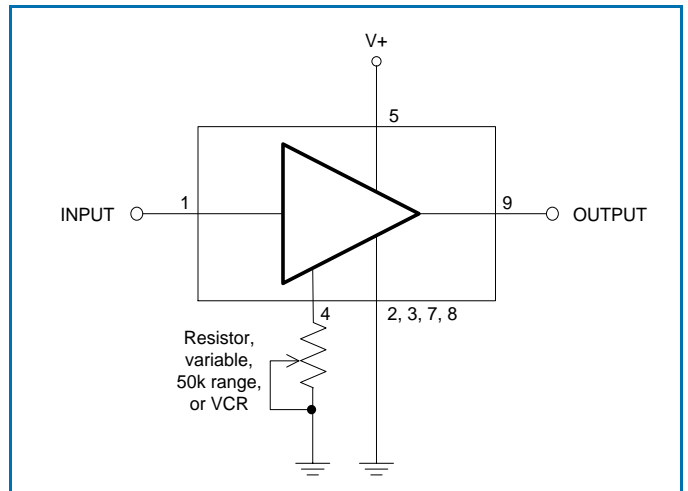
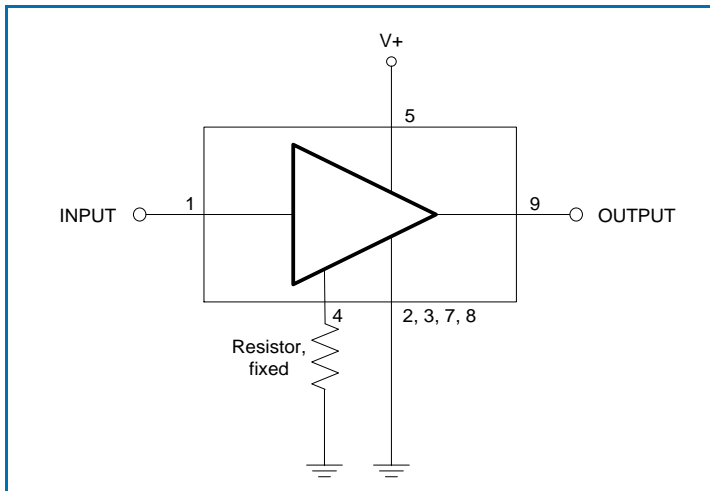

Device current [mA], typical	External resistor [ $\Omega$ ]
470	>50k (open)
450	16k
430	7k5
400	3k9
370	2k4
340	1k5
150	0 (short)

$V_+ = 24V$ ;  $T_{MB} = 30^\circ C$ ;  
 $Z_S = Z_L = 75\Omega$

# QPA3240

## Change of Distortion Performance Over Current

Test Condition:  $V_{+}=24V$ ,  $T_{MB} = 30^{\circ}C$ ;  $Z_S = Z_L = 75\Omega$ ,  $V_O = 62.0dBmV$  at 1000MHz, 18dB extrapolated tilt, 79 analog channels plus 75 digital channels (-6dB offset)

CTB change over device current, typical values

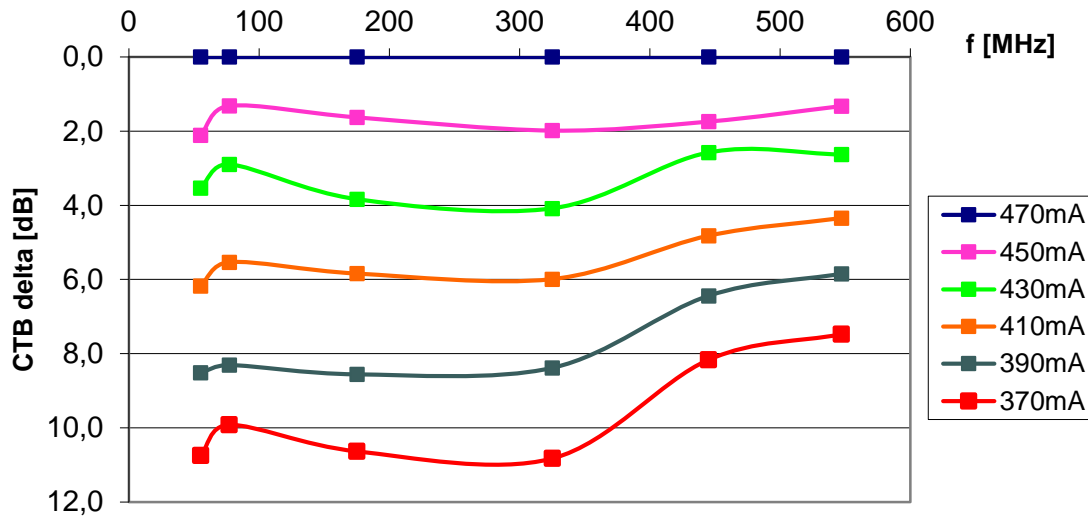

CIN change over device current, typical values

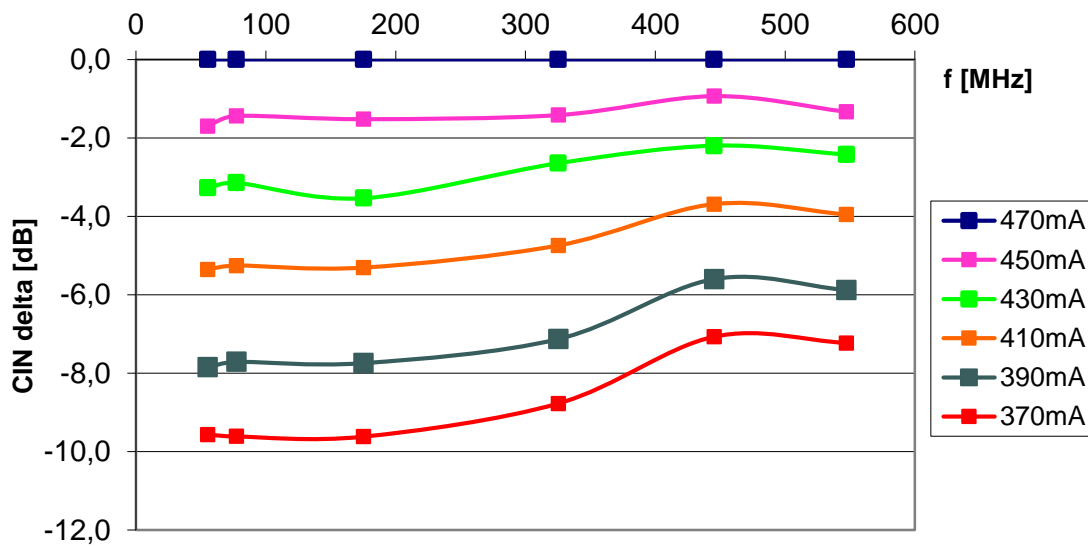

# QPA3240

## Package Drawing (Dimensions in millimeters)

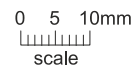
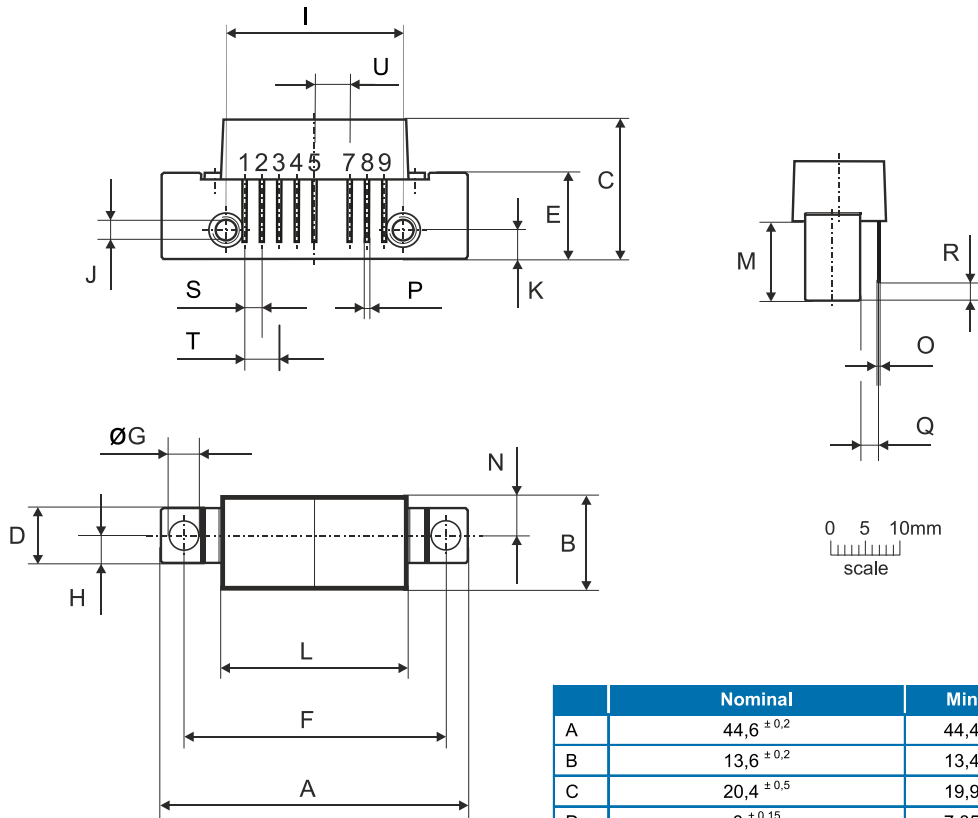

**Notes:**

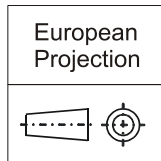

**Pinning:**

Pin	Name
1	Input
2-3	GND
4	CURRENT SETTING
5	V+
6	
7-8	GND
9	Output

	Nominal	Min	Max
A	44,6 ± 0,2	44,4	44,8
B	13,6 ± 0,2	13,4	13,8
C	20,4 ± 0,5	19,9	20,9
D	8 ± 0,15	7,85	8,15
E	12,6 ± 0,15	12,45	12,75
F	38,1 ± 0,2	37,9	38,3
G	4 <sup>+0,2/-0,05</sup>	3,95	4,2
H	4 ± 0,2	3,8	4,2
I	25,4 ± 0,2	25,2	25,6
J	UNC 6-32	-	-
K	4,2 ± 0,2	4,0	4,4
L	27,2 ± 0,2	27,0	27,4
M	11,6 ± 0,5	11,1	12,1
N	5,8 ± 0,4	5,4	6,2
O	0,25 ± 0,02	0,23	0,27
P	0,45 ± 0,03	0,42	0,48
Q	2,54 ± 0,3	2,24	2,84
R	2,54 ± 0,5	2,04	3,04
S	2,54 ± 0,25	2,29	2,79
T	5,08 ± 0,25	4,83	5,33
U	5,08 ± 0,25	4,83	5,33

QPA3240

## Contact Information

For the latest specifications, additional product information, worldwide sales and distribution locations:

**Web:** [www.rfmd.com](http://www.rfmd.com) **Tel:** 1-844-890-8163  
**Email:** [customer.support@qorvo.com](mailto:customer.support@qorvo.com)

For information about the merger of RFMD and TriQuint as Qorvo:

**Web:** [www.qorvo.com](http://www.qorvo.com)

## Important Notice

The information contained herein is believed to be reliable. RFMD makes no warranties regarding the information contained herein. RFMD assumes no responsibility or liability whatsoever for any of the information contained herein. RFMD assumes no responsibility or liability whatsoever for the use of the information contained herein. The information contained herein is provided "AS IS, WHERE IS" and with all faults, and the entire risk associated with such information is entirely with the user. All information contained herein is subject to change without notice. Customers should obtain and verify the latest relevant information before placing orders for RFMD products. The information contained herein or any use of such information does not grant, explicitly or implicitly, to any party any patent rights, licenses, or any other intellectual property rights, whether with regard to such information itself or anything described by such information.

RFMD products are not warranted or authorized for use as critical components in medical, life-saving, or life-sustaining applications, or other applications where a failure would reasonably be expected to cause severe personal injury or death.